

REVISION HISTORY							
REV	BY	DESCRIPTION	DATE	CHKD	APPR	EXT AP	CL APP
2	DB	Changes to model and showcase updated.	08.10.14	DB	IH		

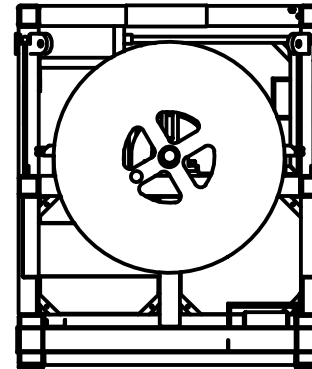

B-B (1 : 30)
Cut thru Section

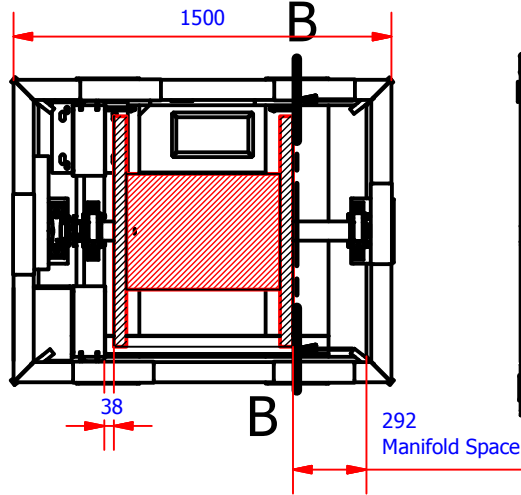
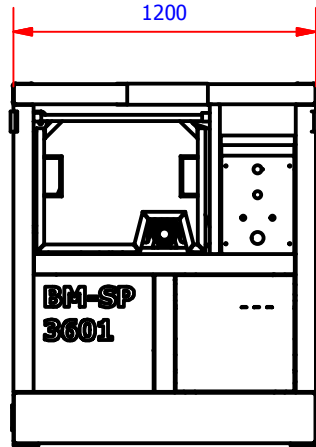
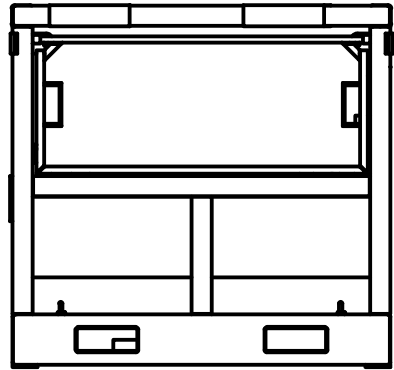
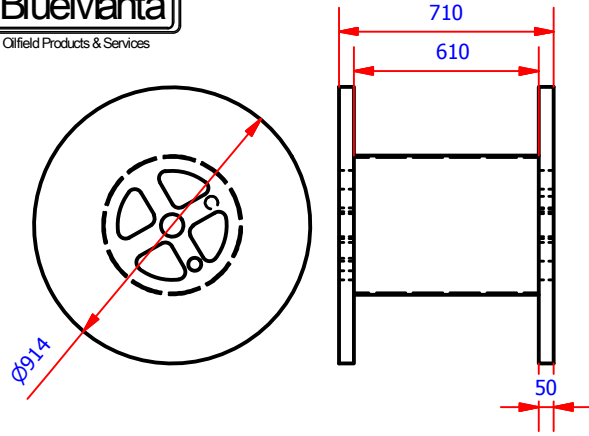
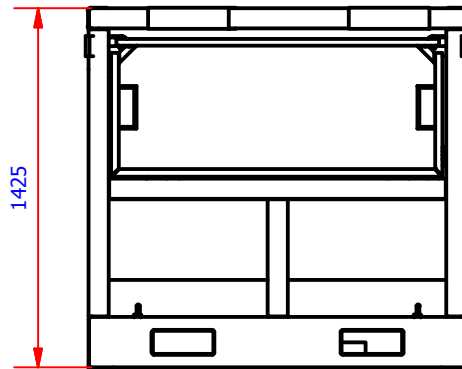

Max Drum: 36" Dia x 30" W, 3" Shaft

This drawing is copyright© and is the property of Blue Manta International, and must not be reproduced or used without the express permission of Blue Manta International.

General tolerances UNO
Steel fabrications: ± 3.00mm
Machining: ± 0.25mm
Concentric: ± 0.05mm
Angular: ± 30mins

Machined corner rads.
Inside: ± 0.50mm UNO
Outside: ± 0.65mm UNO

Description: **36" Spooling Unit**

Part no: -

Drawing No: **BMD-819.S**

Client: **Bluemanta**

Scale: **NTS @ A4**

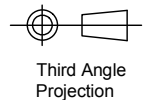

Third Angle
Projection

Notes:
Design Standard DNV 2.7-1
Model Number: 02-3600
Tare: 700 kg
S.W.L: 1300 kg
Gross: 2000 kg